

# Marana

sCMOS

## **NEW** Ultimate Sensitivity Back-illuminated sCMOS Camera for Astronomy and Physical Sciences

### Key Specifications

- -45 °C Vacuum Cooled
- 95% QE
- 4.2 Megapixel
- 11  $\mu\text{m}$  pixels
- 48 fps

### Key Benefits

- ✓ Largest field of view for astronomy
- ✓ Lowest noise back-illuminated sCMOS
- ✓ UV optimized option – wafer inspection, ultra-cold atom studies
- ✓ Vacuum protection of sensor – no moisture / no QE sensitivity decay



# What is Marana?



**Marana** is Andor's new flagship high performance, vacuum cooled sCMOS camera platform, specifically for applications within the physical sciences and astronomy. It has been designed from the ground up to deliver unparalleled performance and versatility. The Marana platform makes its debut with **Marana 4.2B-11**: the most sensitive back-illuminated sCMOS camera available on the market.

## World's Most Sensitive Back-illuminated sCMOS

Marana 4.2B-11 back-illuminated sCMOS camera features **95% Quantum Efficiency** and Andor's unique **vacuum cooling to -45°C**, thus also minimizing noise. Since back-illuminated sensors are chosen specifically for enhanced sensitivity, it makes sense to choose the most sensitive adaptation of this high end technology. Furthermore, a UV-optimized version provides extended QE coverage below 400 nm, including 266 nm.

## Large Field of View... Unlocked

The GSENSE400BSI sensor of Marana has an impressive 32 mm diagonal. However, camera companies to date have not been able to utilize it without severe restrictions, the reason being that the native operation of the sensor exhibits edge glow! The approach so far has either been to live with the glow, only use the middle region of the sensor, or firmware restrict exposure times to much less than 100 ms in order to contain its impact on experiments.

Marana 4.2B-11 features a unique approach to overcome the glow and unlock the full sensor array, presenting an exclusive solution for capturing a large field of view across a wide range of exposure conditions, up to 20 secs.

### How do we benefit from larger field of view?

- ✓ Search more sky – Space Debris and NEO tracking
- ✓ Capture Sun Spots & Solar Flares
- ✓ Tomography – reconstruct larger objects without sacrificing resolution
- ✓ Plasma studies
- ✓ Wafer inspection with high throughput (266 nm)
- ✓ Extended High Density Multi-track spectroscopy
- ✓ Hyperspectral imaging and Spectral Interferometry

### How do we benefit from enhanced sensitivity?

- ✓ Space debris & NEO – track smaller objects
- ✓ Detect smaller occultations
- ✓ Lower laser powers – preserve photosensitive samples
- ✓ Shorter exposures – follow fast events, e.g. pulsars and fast reactions
- ✓ Lower detection limits / trace concentrations
- ✓ Higher dynamic range photometry
- ✓ AO wavefront sensing on weaker signals
- ✓ Extremely narrowband filters (e.g. Solar)
- ✓ Fluorescence down to single ultra-cold atoms

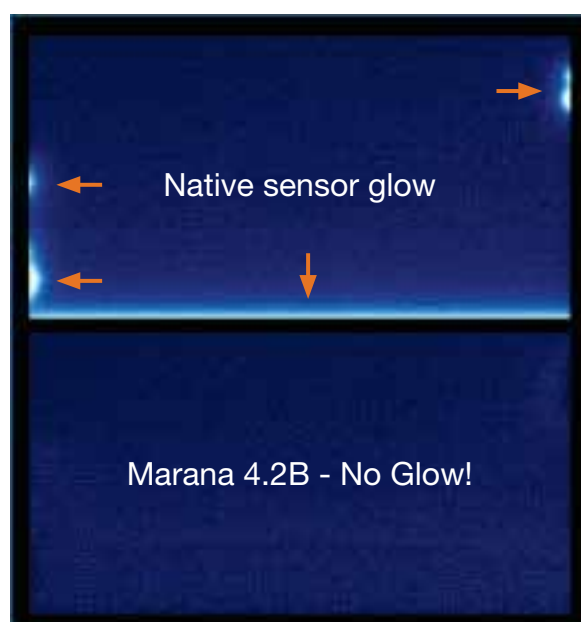

Dark exposure (1 s), using a 1024 x 2048 region of the GSENSE400 BSI sensor. Images are compared: upper - without, and lower - with the Anti-Glow Technology of Marana 4.2B-11, employing the exact same intensity scaling.

# Features and Benefits

Feature	Benefit
<b>95% QE &amp; Lowest Noise</b>	Maximum signal to noise for light starved measurements. Detect smaller orbital debris; BEC fluorescence.
<b>4.2 Megapixel and 32 mm diagonal</b>	Largest field of view sCMOS, compatible with wide range of acquisition times. Large sky scanning; Tomography.
<b>UV-optimized QE option</b>	Enhanced UV sensitivity between 260 - 400nm. Wafer Inspection (266nm).
<b>Vacuum Cooled to -45°C</b>	Very weak signals require lowest noise floor and longer exposures: Don't be limited by camera thermal noise!
<b>The ONLY Vacuum Back-illuminated sCMOS</b>	Ultimate performance lifetime. Andor's proprietary UltraVac™ technology protects the sensor from moisture and QE degradation over time.
<b>Anti-Glow Technology</b>	Allows access to full array with longer exposures - field of view and sensitivity advantages.
<b>48 fps (4.2 Megapixel)</b>	Image highly dynamic scenes without signal smear. Space debris tracking; NEOs.
<b>Extended Dynamic Range Mode</b>	'One snap quantification' across a 53 000:1 signal range - perfect for Photometry.
<b>&gt; 99.7% Linearity</b>	Market leading quantitative accuracy over the whole signal range.
<b>Superfast Spectroscopy Mode</b>	On-head vertical pixel binning, ideal for dynamic spectroscopy (up to >24,000 spectra/sec).
<b>Binning bit-depth up to 32-bit</b>	Extend camera dynamic range in extensive on-head binning scenarios.
<b>Adaptive Optics Mode</b>	Minimize lag after data collection - transfer of row data immediately after exposing.
<b>User configurable Region of Interest (ROI)</b>	Image only what is necessary. Accelerate frame rates and save data storage space.
<b>Fan and Water cooling as standard</b>	Water cooling for maximum sensitivity.
<b>USB 3.0 ('USB 3.1 Gen 1')*</b>	A convenient, universally available high speed interface.

## UltraVac™ - Why is Vacuum Technology Important?

As well as affording superior minimization of the noise floor, the performance longevity benefits of Andor's vacuum sensor enclosure should not be overlooked:

### Reason 1: Sensor Protection

Unless protected by vacuum, back-illuminated silicon sensors are susceptible to attack from moisture, hydrocarbons and other gas contaminants, resulting in gradual performance decline, **including QE decline.**

### Reason 2: No re-backfilling of sensor enclosure

UltraVac™ uses a **hermetic vacuum seal**, completely preventing any gas and moisture ingress from the outside environment. This avoids moisture condensation on the sensor and the need to return to factory for repair.

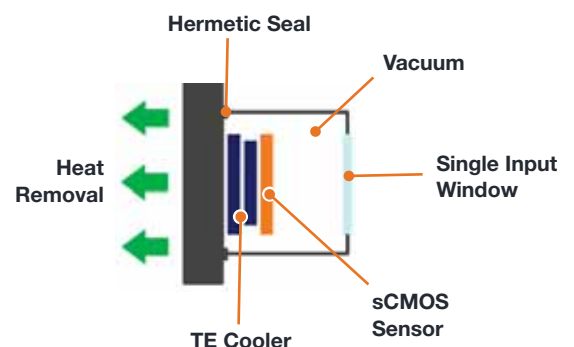

Andor's UltraVac™ provides superior sensor protection and longevity.

## Low Maintenance Astronomy

The longevity benefits of Marana are particularly relevant to the needs of astronomers, where cameras are often in remote unmanned observing locations and need to operate without service intervention, over long durations of time. This ultimately translates not only into a higher experimental throughput, but also into a lower cost of ownership.

## Quantitative Accuracy

Marana 4.2B-11 offers an **Extended Dynamic Range (EDR)** functionality, supported by a 16-bit data range. Harnessing an innovative 'dual amplifier' sensor architecture, we can access the maximum pixel well depth AND the lowest noise simultaneously, ensuring that we can **quantify extremely weak and relatively bright signal regions in one acquisition**, ideal for example, in astronomical photometry.

### A - Extended Dynamic Range Mode (16-bit)

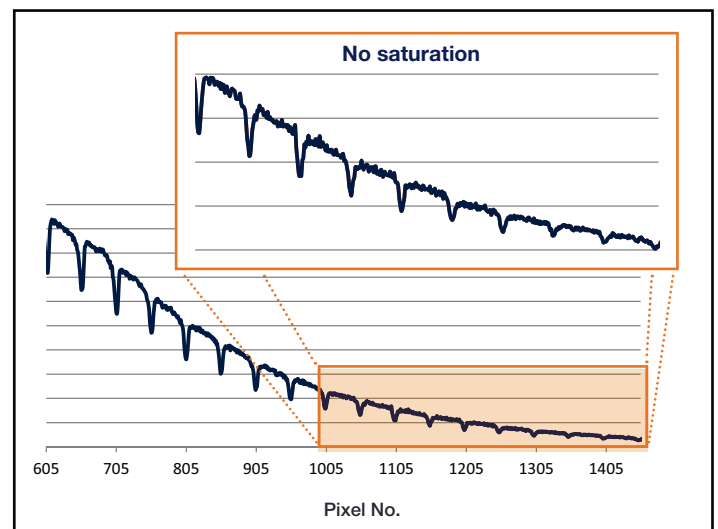
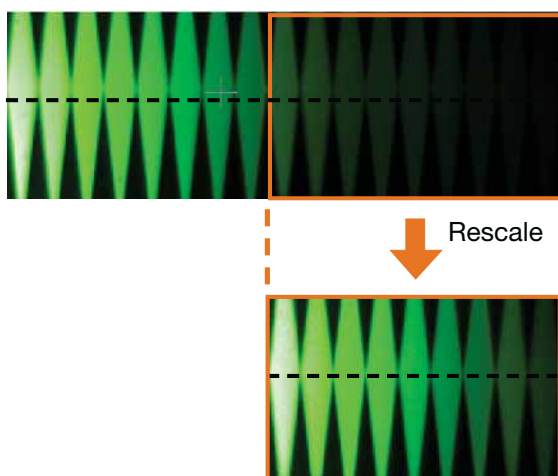

### B - High Speed Mode (12-bit)

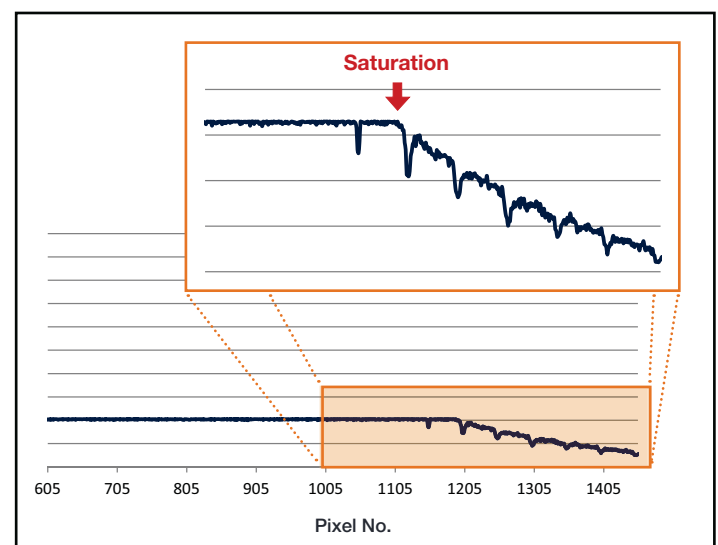
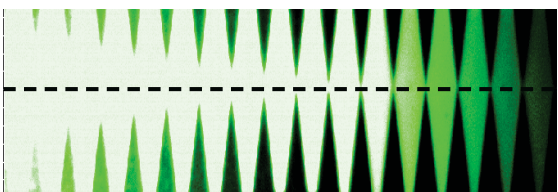

## Rapid Frame Rates

Marana 4.2B-11 offers **fast frame rate capability**, ideal for imaging even the most dynamic changes such as space debris tracking, pulsars, solar events and fast reaction kinetics spectroscopy. Region of Interest (ROI) and/or 12-bit readout mode can be utilized to considerably further boost frame rates, offering solutions to wavefront sensing and fast spectroscopy applications.



## Quantum Efficiency (QE) Curves

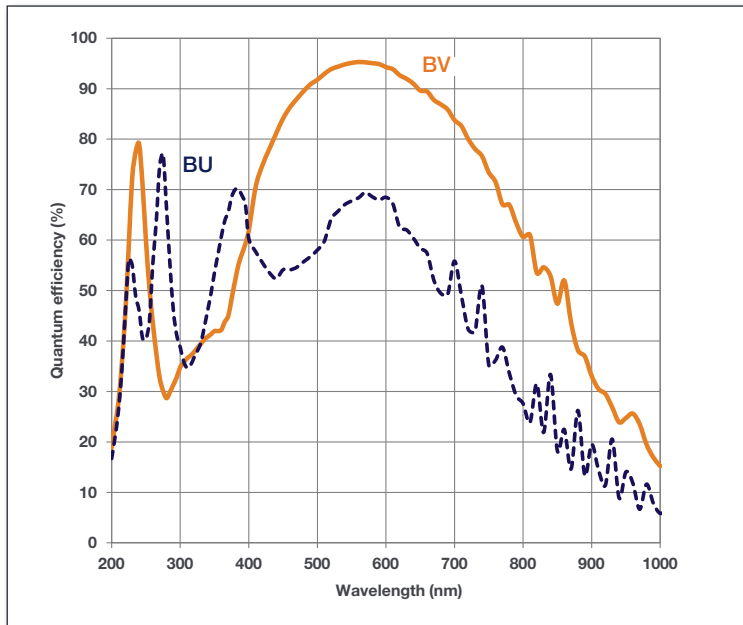

*“Marana 4.2B-11 comes with two sensor options, ‘BV’ and ‘BU’. Each offer a particular performance profile across the Vis and Blue/UV regions”*

### Sensor Options

- **BV:** Standard option - provides a broad response through the visible region with an additional peak at 250 nm.
- **BU:** Option optimized for the UV region with higher sensitivity from 250 to 400 nm.

## sCMOS for Spectroscopy and Andor Research-grade Spectrographs

Highly modular motorized platforms with dual output ports, dual/triple/quadruple grating turrets and a wide range of field-upgradable accessories.

### Shamrock 750

Delivers the highest spectral resolution of the spectrograph range, down to 0.02 nm.

### Shamrock 500i

Ideal combination of high spectral resolution, imaging capabilities for multi-track acquisitions. Convenient USB interface alongside fully motorized platform and light coupling accessories.

### Kymera 193i

Intelligent, modular and compact imaging spectrograph with Adaptive Focus technology, fully motorized, RFID-tagged dual grating turret, dual detector output ports and seamless interfacing to microscopes for micro-spectroscopy applications.

### Kymera 328i

Intelligent, modular and compact imaging spectrograph with Adaptive Focus technology and intelligent TruRes™ spectral resolution enhancement option. Quad grating turret and dual input and output ports allow ease of integration into demanding optical setups or multi-modal laboratories.



# Marana 4.2B-11

## The Physicist's Choice

The Marana 4.2B-11 back-illuminated sCMOS camera is ideally suited to a wide range of demanding applications within physics, astronomy and materials science.

### Performance & Adaptability

**Large FOV Astronomy** – 32 mm diagonal sensor, perfect for capturing more sky.

**UV Options** – two versions of the sensor, each with distinct UV wavelength coverage. Find a solution matched to your exact line of interest.

**Superfast Spectroscopy Mode** – on-head vertical pixel binning of a single track, ideal for dynamic spectroscopy (>24 000 spectra/sec).

**AO Mode** – transmit image data with minimal lag; as soon as a row exposes, it goes!

**Extended Dynamic Range** – novel pixel architecture means you don't need to pre-select gain. Access lowest read noise and full well depth simultaneously.

**Lowest Dark Current** – low read noise is complemented by extremely competitive darkcurrent, also ensuring minimized hot pixel blemishes.

**Cooling Options** – fan and water cooled capability, offering flexibility to your experimental environment.

**Blemish correction maps and advanced control** – Andor provide the capability to turn off/on blemish correction for those who prefer to perform this themselves. Bespoke blemish maps can also be provided.

**GPU Express** – for real time processing on GPU.

**Extended Number of Spectral Channels with large FOV (22.5mm x 22.5mm)** – for High Density Multitrack Spectroscopy and Hyperspectral Imaging.

#### **Near Earth Object and Space Debris**

Highest available QE sensitivity to detect smaller objects, alongside large FOV for maximum sky coverage.

#### **Tomography (Neutron or X-ray)**

For high throughput 3D tomography (or even 4D: 3D + time), the Marana 4.2B-11 back-illuminated sCMOS, with large field of view 32mm sensor and 95% QE, presents a superb solution. Lens/scintillator coupled tomography using Marana enables reconstruction of large objects without sacrificing resolution and clarity.

#### **Hyperspectral imaging and High Density Multitrack Spectroscopy**

Often there is a desire for the highest number of spectral channels possible with ideal resolution; the large FOV and ideal pixel size of Marana offers significant extensions to these techniques.

#### **Wavefront Sensing**

A 128x128 ROI yields almost 800 fps, and individual pixel rows can be transmitted immediately after recording for on-the-fly image processing with minimal time lag.

#### **Solar Astronomy**

Follow dynamic solar processes over an extended field of view. High QE affords enhanced performance with narrow band imagers.



#### **UV Flexibility**

Marana 4.2B-11 comes with two sensor options, 'BV' and 'BU'. Each offer a particular performance profile across the Blue/UV region, with the 'BU' sensor in particular showing greater optimization across this range, offering high QE solutions for both 266 nm and 355 nm laser lines.

# Technical Data

## Performance Specifications\*<sup>2</sup>

Model	Marana 4.2B-11
Sensor Type	Back-Illuminated Scientific CMOS
Array Size	2048 (W) x 2048 (H) 4.2 Megapixel
Pixel Size	11 x 11 $\mu\text{m}$
Image Area	22.5 mm x 22.5 mm (31.9 mm diagonal)
Readout Modes	Rolling Shutter and simulated Global Shutter
Pixel Readout Rates	100 MHz (16-bit mode) 200 MHz (12-bit mode)
Quantum Efficiency <sup>3</sup>	95% (max)
Read Noise (e <sup>-</sup> ) median	1.6 e <sup>-</sup> (at any readout rate)
Sensor operating temperature <sup>4</sup>	
Air cooled	-30°C (@30°C ambient)
Water/liquid cooled	-45°C (@10°C water)
Dark Current	
Air cooled (@-25°C)	0.4 e <sup>-</sup> /pixel/s
Water/liquid cooled (@ -45°C)	0.2 e <sup>-</sup> /pixel/s
Active area pixel well depth	85 000 e <sup>-</sup>
Dynamic Range	53 000:1
Data Range	16-bit (extended dynamic range) 12-bit (maximum frame rate)
Linearity <sup>6</sup>	> 99.7%
Photon Response Non Uniformity (PRNU)	< 0.5% (@ half-light range)
Region of Interest (ROI)	User-definable, 1 pixel granularity, min. size 1 (h) x 25 (w)
Pre-defined ROI	1608 x 1608, 1200 x 1200, 1024 x 1024, 512 x 512, 128 x 128
Pixel Binning (on FPGA)	Pre-set options: 2x2, 3x3, 4x4, 8x8. User definable binning (including asymmetric) to 1-pixel granularity.

## General Specifications \*<sup>2</sup>

Model	Marana 4.2B
I/O	O: Fire Row 1, Fire Row n, Fire All, Fire Any, Arm I: External
Trigger Modes	Internal, External, External Start, External Exposure, Software
Software Exposure Events <sup>5</sup>	Start exposure - End exposure (row 1), Start exposure - End exposure (row n)
Hardware Timestamp Accuracy	25 ns
PC Interface	USB 3.0 <sup>7</sup>
Camera Window	AR coated UV grade fused silica window
Lens Mount	F-mount*
f-number	F-mount: f/ 3.75 (Cone angle 15°) Faceplate ('no optical mount'): f/3.25 (Cone angle 17.5°) Custom mount: f/0.7 (Cone angle 72°)**

\* Optional user-switchable C-mount accessory available for use with smaller ROI sizes. The F-mount may also be readily removed to use Marana with a simple faceplate, for example on an optical table.

\*\* Through Andor's Customer Special Request (CSR) service, custom optical mounts can be tailored to your specific optical needs, e.g. low f/# telescope mounting.

## Frame Rates

ROI Size (W x H)	Max Frame Rate (fps)		ROI area (of sensor)	Example scenarios of use
	16-bit	12-bit		
2048x2048	24	48	22.5mm x 22.5mm	Full FOV imaging, Space debris, NEOs, Hyperspectral
2048 x 1200	41	81	22.5mm x 13.2mm	
1608x1608	30	61	17.7mm x 17.7mm	Reduced ROI, faster frame rates
1400x1400	35	70	15.4mm x 15.4mm	
1200x1200	41	81	13.2mm x 13.2mm	
1024x1024	48	95	11.3mm x 11.3mm	
512x512	95	190	5.6mm x 5.6mm	
256x256	190	378	2.8mm x 2.8mm	
128x128	378	750	1.4mm x 1.4mm	
2048x8	5415	9747	22.5mm x 88µm	Single or dual track spectroscopy
2048x2	16244	24367	22.5mm x 22µm	Single track spectroscopy
2048x1	24367	24367	22.5mm x 11µm	Single track spectroscopy with ultrafast rates

Note: frame/spectral rates do not differ if partial or full rows are selected.

## Flexible Connectivity

- 1 USB 3.0<sup>7</sup>**  
A convenient, universally available high speed interface
  - 2 TTL / Logic**  
Connector type: 15-way D-type to BNC cable with Fire (Output), External Trigger (Input), Shutter (Output)
  - W Water Cooling**  
Connection to recirculator or other water/liquid cooling system is possible for maximum sensitivity
  - P Power**  
Connection to PSU refer to power requirements on page 12
- Notes:**  
Minimum cable clearance required at rear of camera: 100 mm

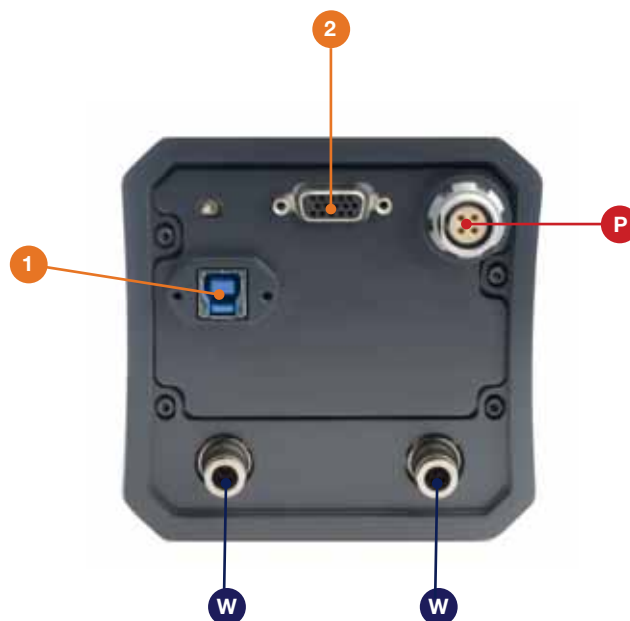



# Meet the Extended sCMOS Family for Physical Sciences

## Marana 4.2B-11 sCMOS

Ultimate sensitivity and FOV - For astronomy and echelle spectroscopy

- ✓ Near Earth Object (NEO) detection
- ✓ Space debris tracking
- ✓ Solar astronomy
- ✓ Fast Time Resolution Astrophysics
- ✓ Wafer inspection
- ✓ Optical Emission Spectroscopy (OES)
- ✓ Hyperspectral imaging
- ✓ Neutron Tomography



## Zyla sCMOS

For physical imaging, astronomy and spectroscopy

- ✓ Particle Image Velocimetry (PIV)
- ✓ Lucky/Speckle imaging
- ✓ Solar astronomy
- ✓ Bose Einstein Condensation (BEC)
- ✓ Adaptive Optics (AO)
- ✓ Fluorescence Correlation Spectroscopy (FCS)

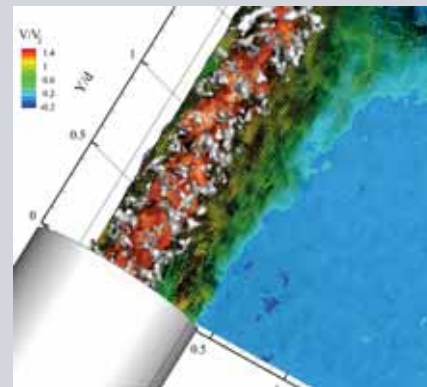

3D flow field study by PIV (using 4x Zyla), courtesy of Gioacchino Cafiero, Università di Napoli Federico II.

## iStar sCMOS

For nanosecond gated imaging and spectroscopy

- ✓ Quantum physics
- ✓ Plasma diagnostics
- ✓ Flow/Spray/Combustion processes study
- ✓ Planar Laser-Induced Fluorescence (PLIF)
- ✓ Time-resolved luminescence
- ✓ Laser Induced Breakdown Spectroscopy (LIBS)

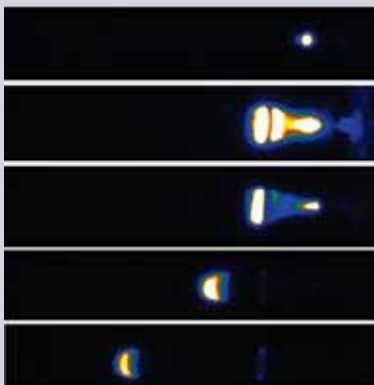

Plasma bullet time-dynamics studies, courtesy of Jérôme Bredin at York Plasma Institute.

## Zyla-HF

For indirect x-ray imaging

- ✓ Hard x-ray imaging and spectroscopy
- ✓ High Harmonic Generation (HHG)
- ✓ X-ray plasma spectroscopy
- ✓ X-ray tomography
- ✓ Transmission Electron Microscopy (TEM)

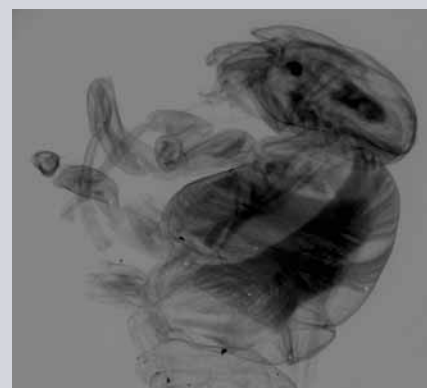

X-ray absorption image of a wasp taken with a 40 kV X-ray source, courtesy of Crytur.

# Creating The Optimum Product for You

## Step 1. Choose the camera type



Camera Type

Description	Code
Marana 4.2B-11, VIS/NIR optimized, 4.2 Megapixel, 32 mm diagonal, 48 fps, USB 3.0, F-mount	MARANA-4BV11
Marana 4.2B-11, UV-optimized, 4.2 Megapixel, 32 mm diagonal, 48 fps, USB 3.0, F-mount	MARANA-4BU11

## Step 2. Select an alternative camera window (optional)



Camera Window

The standard window has been selected to satisfy most applications. However, other options are available. The alternative camera window code must be specified at time of ordering.

To view and select other window options please refer to the t which gives the transmission characteristics, product codes and procedure for entering the order. Further detailed information on the windows can be found in the Technical note – '[Camera Windows: Optimizing for Different Spectral Regions](#)'.

## Step 3. Select the required accessories



Accessories

Description	Order Code
C-mount - convert Marana 4.2B-11 to C-mount (for use with ROIs)	ACC-MEC-11936
Mounting flange for Kymera 328i and 193i spectrographs	MFL-SR-MARANA
Mounting flange for the Holospec spectrograph	HS-FLG-MARANA
Mounting flange for the Shamrock 500i	MFL-SR500-MARANA
Re-circulator for enhanced cooling performance (supplied with 2x2.5 m tubing as standard)	XW-RECR
Oasis 160 Ultra compact chiller unit (tubing to be ordered separately)	ACC-XW-CHIL-160
6 mm tubing options for Oasis 160 Ultra compact chiller (2x2.5 m or 2x5m lengths)	ACC-6MM-TUBING-2X2.5 ACC-6MM-TUBING-2X5M

Note: Other mounting options are available through our CSR process - please contact your sales representative.

## Step 4. Select the required software



Software

Marana requires one of the following software options:

**Solis** A 32-bit and fully 64-bit enabled application for Windows (7, 8, 8.1 and 10) offering rich functionality for data acquisition and processing. AndorBasic provides macro language control of data acquisition, processing, display and export.

**Andor SDK3** A software development kit that allows you to control the Andor sCMOS cameras from your own application. Available as 32 and 64-bit libraries for Windows (7, 8, 8.1 and 10) and Linux. Compatible with C/C++, LabView and Matlab.

**GPU Express** Andor GPU Express library has been created to simplify and optimize data transfers from camera to a CUDA-enabled NVidia Graphical Processing Unit (GPU) card to facilitate accelerated GPU processing as part of the acquisition pipeline. Integrates easily with Andor SDK3 for Windows.

### Third party software compatibility

Drivers are available so that the Marana can be operated through a large variety of third party software packages. See Andor web site for detail: <http://www.andor.com/scientific-software>

## Have you found what you are looking for?

**Need faster frame rates?** The Zyla sCMOS platform, configured with CameraLink interface, can deliver 100 fps from a full 5.5 or 4.2 Megapixel array, faster still with sub-array selection.

**Need more sensitivity?** The iXon Ultra EMCCD platform offers single photon sensitivity and 95% back-illuminated QE, further boosted by cooling to -80°C. Ideal for demanding light starved or single photon counting applications such as quantum entanglement studies.

**Need smaller pixels?** The Neo and Zyla sCMOS cameras offer sensors with 6.5 µm pixel pitch.

**Need better NIR performance?** The iKon-M and iKon-L range of CCDs offer NIR-Enhanced QE options ('BR-DD' and 'BEX2-DD'), extending sensitivity deep into the NIR range. Ideal for exoplanet detection on dwarf stars as well as 785nm laser usages (e.g. BEC and NIR Raman).

# Mechanical Drawings

Dimensions in mm [inches]

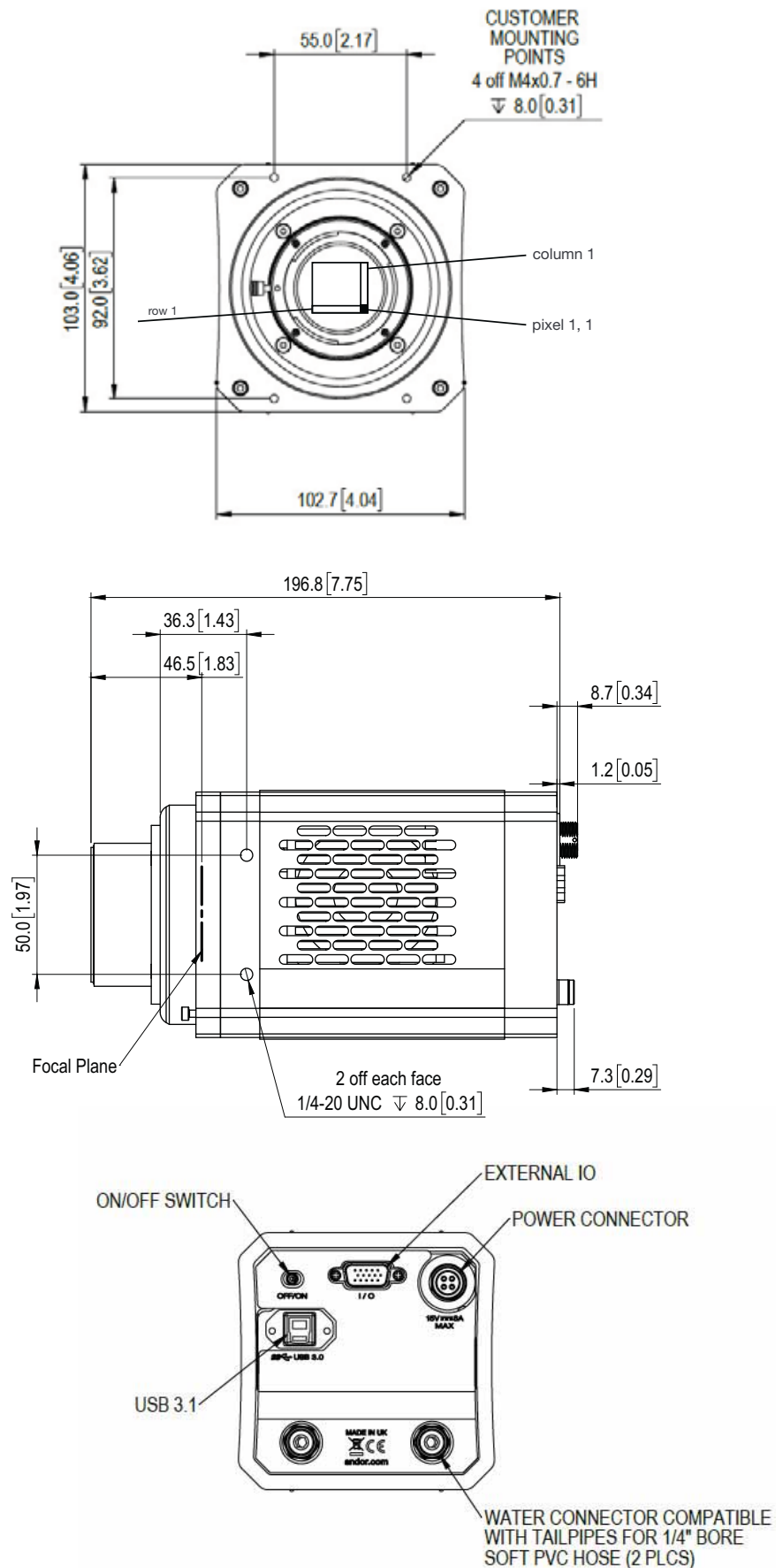

Weight: ~2.7 kg [5.95 lbs] approx

# ORDER TODAY

Need more information? At Andor we are committed to finding the correct solution for you. With a dedicated team of technical advisors, we are able to offer you one-to-one guidance and technical support on all Andor products. For a full listing of our local sales offices, please see: [andor.com/contact](http://andor.com/contact)



Our regional headquarters are:

**Europe**

Belfast, Northern Ireland  
Phone +44 (28) 9023 7126  
Fax +44 (28) 9031 0792

**Japan**

Tokyo  
Phone +81 (3) 6732 8968  
Fax +81 (3) 6732 8939

**North America**

Concord, MA, USA  
Phone +1 (860) 290 9211  
Fax +1 (860) 290 9566

**China**

Beijing  
Phone +86 (10) 8271 9066  
Fax +86 (10) 8271 9055

**Items shipped with your camera**

- 1x USB 3.0 PCIe card\*7
- 1x USB 3.0 Cable (3m)\*7
- 1x Multi I/O Timing Cable (D-type to BNC: 1.5m)
- 1x 15V PSU
- 1x Country specific power cord (5m)
- 1x User manuals in electronic format
- 1x Quickstart Guide

**Footnotes**

1. Assembled in a state-of-the-art facility, Andor's UltraVac™ vacuum process combines a permanent hermetic vacuum seal (no o-rings), with a stringent protocol and proprietary materials to minimize outgassing. Outgassing is the release of trapped gases that would otherwise degrade cooling performance and potentially cause sensor failure.
2. Figures are typical and target specifications and therefore subject to change.
3. Quantum efficiency as supplied by the sensor manufacturer.
4. Coolant temperature must be above dew point.
5. Software Exposure Events provide rapid software notification (SDK only) of the start and end of acquisition.
6. Linearity is measured from a plot of Signal vs. Exposure Time over the full dynamic range.
7. The Marana connects to your control PC using a USB 3.0 connection. This may also be referred to as USB 3.1 (Gen 1). Andor provide a USB 3.0 card and cable, and recommend that these are used to ensure optimum performance.



**Minimum Computer Requirements:**

- 3.0 GHz single core or 2.4 GHz dual or quad core processor
- 8 GB RAM
- Hard drive: 400 MB/s write speed recommended for the data rate associated with the max. frame rates. 250 MB free hard disc to install software
- USB 3.0 slot (or x8 PCIe slot for USB 3.0 card)
- Windows (7, 8, 8.1 and 10) or Linux

**Operating & Storage Conditions:**

- Operating Temperature: 0°C to +30°C ambient
- Operating Altitude: up to 6000m
- Relative Humidity: <70% (non-condensing)
- Storage Temperature: -10°C to 50°C

**Power Requirements:**

- 100 - 240 VAC, 50 - 60 Hz
- Power consumption: 40W typical / 114W max

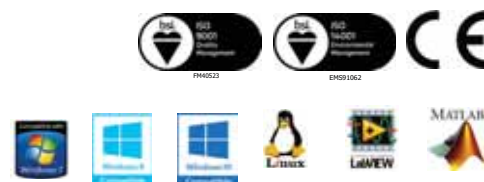

Windows is a registered trademark of Microsoft Corporation. Labview is a registered trademark of National Instruments. Matlab is a registered trademark of The MathWorks Inc.